

# WAREPAD PART NUMBER: STFRI - INSTALLATION INSTRUCTIONS

**SAFETY FIRST:** OSHA guidelines should be followed at all times.

**RECOMMENDED:** Suspension should be in good working condition.

Side plates may be installed on the OEM Hanger while on the trailer frame or off. The EWP Poly Side Plates are designed to fit with or without the EWP Poly Warepads.

## BEFORE STARTING SIDE PLATE INSTALLATION:

- A. CHECK HANGER for existing steel wear pads.
- B. If no steel wear pads, go to Step 1.
- C. If there are steel wear pads installed, go to A and B.

**A** If a steel wear pad is installed on THE SEAT of the HANGER (example shown to right), the steel pad does Not need to be removed. Go to Step B.

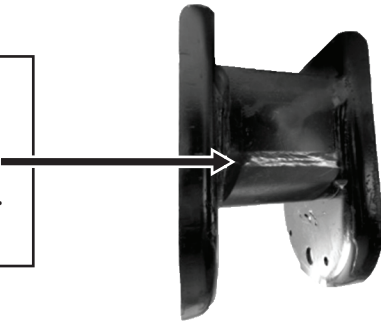

**B.** The inside width of the hanger does not allow for steel side plates and the EWP Side Plates.

**B1:** If this wear pad is installed in the hanger, it is recommended to REMOVE the entire wear pad.

**B2:** Remove any and all protection products that are attached to the Inside wall of the hanger (example shown to right).

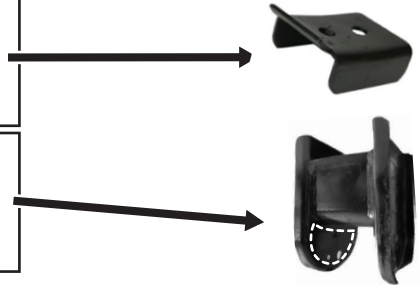

Once the above steel wear pads have been removed, go to Step 1.

**Attachment Hardware per Side Plate Kit:**  
2 – 1/2" Flat Washers  
1 – Sleeve (7/8 OD x .635 ID x 3 1/8")

**Equipment/Tools Needed for Installation:**  
5/8" Drill Bit  
Drill Motor  
Marking Pen

**Step 1:** Remove the existing rebound bolt from the Hanger. Discard the sleeve. **SAVE THE BOLT AND NUT!** The bolt and nut will be used in Step 4.

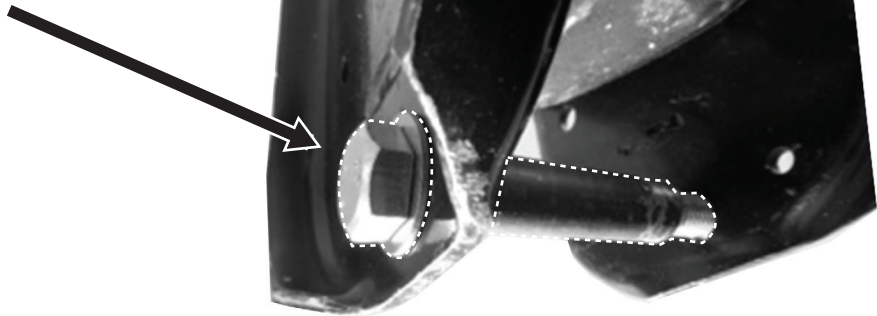

**Step 2:** Use the Hanger Rebound Hole as a guide to mark the Side Plate. Insert the Side Plate as shown into the Hanger. Hold in place. Mark the Side Plate with a marking pen through the Hanger rebound bolt hole.

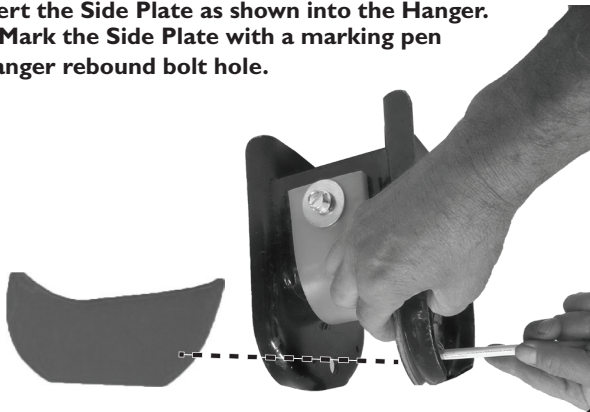

**Step 3:** Remove Side Plate and drill a 5/8" hole at the marked location. Repeat Steps 1-3 for other side of side plate.

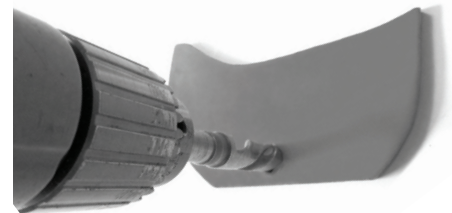

# WAREPAD PART NUMBER: STFR1 - INSTALLATION INSTRUCTIONS

## Step 4A-C: FASTENER INSTALLATION/TIGHTENING.

4A: Insert Side Plates according to diagram.

4B: Install fasteners according to diagram.

Please note: the Rebound Bolt Nut must be tightened so that it creates pressure on the washers that are directly on the EWP Side Plates. This pressure keeps the side plates from moving.

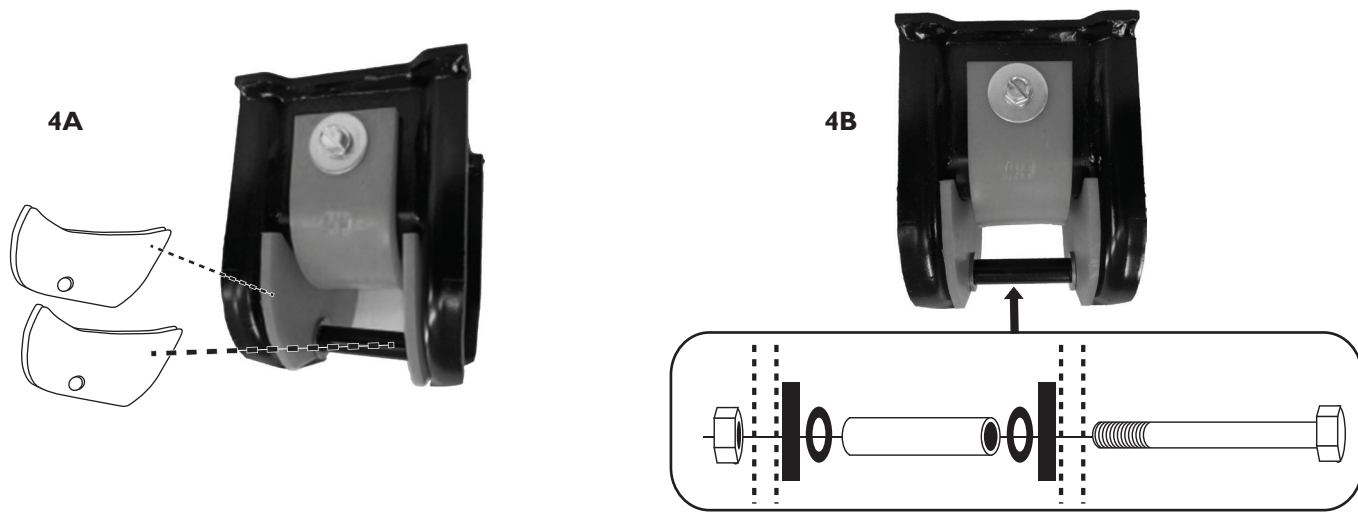

Pictured: A Front Hanger installed with EWP Warepad and Side Plates.



Pictured: A Rear Hanger installed with EWP Warepad and Side Plates.

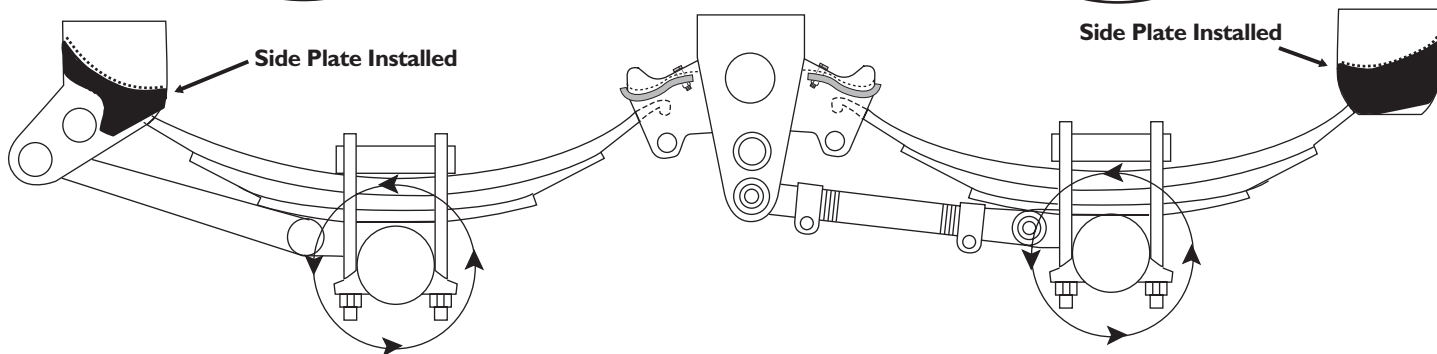

### **EWP Maintenance Recommendation:**

*It is recommended to inspect the Side Plates during routine maintenance schedules and during PM's.*