

WAREPAD PART NUMBER: SRCF1 & SRCF18 - INSTALLATION INSTRUCTIONS

SAFETY FIRST: OSHA guidelines should be followed at all times.

RECOMMENDED: Suspension should be in good working condition.

Side plates may be installed on the OEM Hanger while on the trailer frame or off. The EWP Poly Side Plates are designed to fit with or without the EWP Poly Warepads.

FYI: DRILL HOLE LOCATION FOR THE SIDE PLATES IS IMPORTANT! Please follow the directions in Step 1. If the OEM hanger drill hole is in the incorrect location, the fastener may be sheared off by the spring.

BEFORE STARTING SIDE PLATE INSTALLATION:

- A. CHECK HANGER for existing steel wear pads.
- B. If no steel wear pads, go to Step 1.
- C. If there are steel wear pads installed, go to A and B.

A If a steel wear pad is installed on THE SEAT of the HANGER (example shown to right), the steel pad does Not need to be removed. Go to Step B.

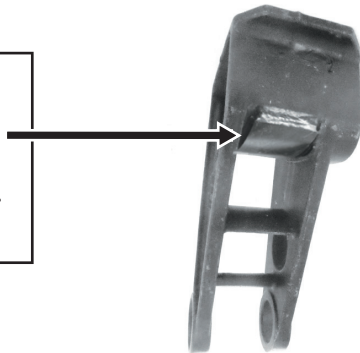

B. The inside width of the hanger does not allow for steel side plates and the EWP Side Plates.

B1: If this wear pad is installed in the hanger, it is recommended to REMOVE the entire wear pad.

B2: Remove any and all protection products that are attached to the Inside wall of the hanger (example shown to right).

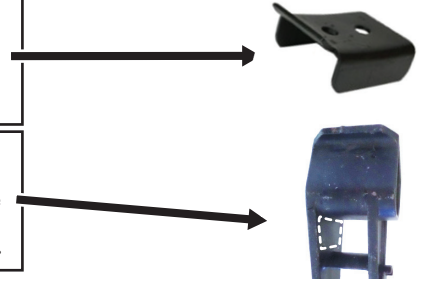

Once the above steel wear pads have been removed, go to Step 1.

Attachment Hardware per Side Plate Kit:

- 4 - 5/16" Flat Washers
- 2 - 5/16" Self Locking Nuts
- 2 - 5/16" x 1" Bolts (Grade 5 or above)

Equipment/Tools Needed for Installation:

- 5/16" Drill Bit
- 1/2" Open End Box Wrench
- Drill Motor
- 3/8" Drive Ratchet Wrench
- Marking Pen
- 3/8" Drive 1/2" Socket
- Red Loctite Series 271

Step 1: Mark drill hole location for bolts according to drawing.

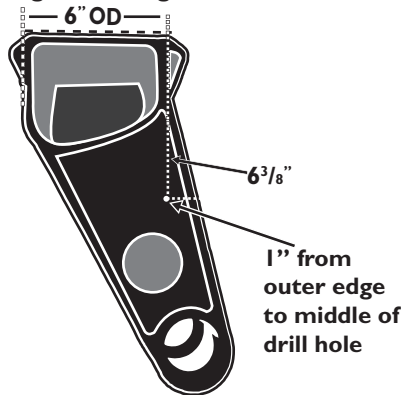

Step 2: Drill a 5/16" hole at the drill hole location.



Step 3: Use the drilled Hanger as a guide to mark the Side Plate. Insert the Side Plate as shown into the Hanger. Hold in place. Mark the Side Plate with a marking pen through the Hanger drill hole.

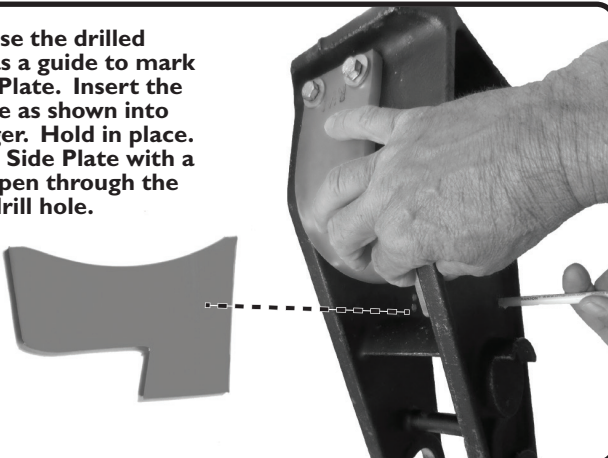

Step 4: Remove Side Plate and drill a 5/16" hole at the marked location. Repeat Steps 1-4 for other side of Side Plate.



WAREPAD PART NUMBER: SRCF1 & SRCF18 - INSTALLATION INSTRUCTIONS

Steps 5A-C: FASTENER INSTALLATION/TIGHTENING.

5A. Use Red Loctite Series 271 on the thread of the bolt when installing fasteners.

5B: Install fasteners according to diagram in Step 6.

5C: Bolt tightness. There is no torque for bolt tightness. Snug the bolt. Bolt tension should be done **MANUALLY** with a 3/8" Drive 1/2" Socket. Maximum tightening is reached when the Flat Washer presses into the polypad surface to cause a minor indentation. The washer may bend slightly. **CAUTION! DO NOT OVER-TIGHTEN TO CAUSE** the washer to invert or buckle.



Step 6: Place the Side Plate into the OEM Hanger as shown. Line up holes. The Head of the Bolt should be on the inside of the Hanger. Install fasteners **MANUALLY** (Steps 5A-C) with Red Loctite Series 271 on the thread of the bolt.

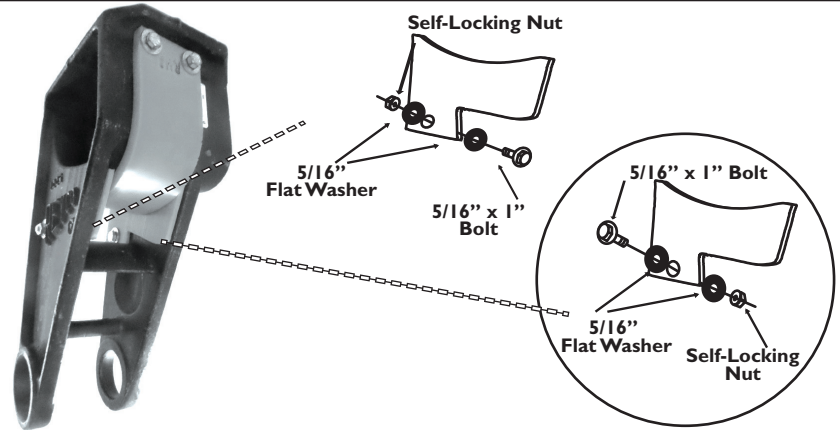

Pictured: A Front Hanger installed with EWP Warepad and Side Plates.

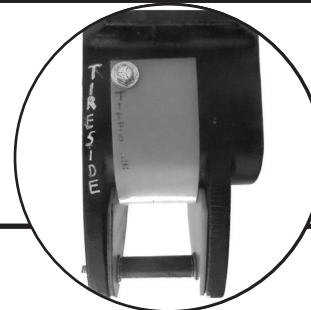

Pictured: A Rear Hanger installed with EWP Warepad and Side Plates.

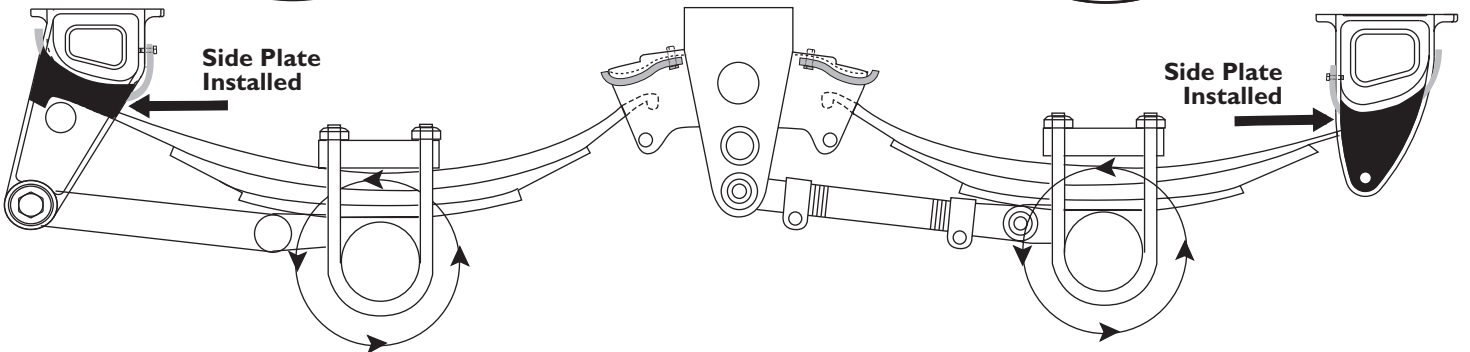

EWP Maintenance Recommendation:

It is recommended to inspect the Side Plates during routine maintenance schedules and during PM's.