

# WAREPAD PART NUMBER: EWP HH1 - INSTALLATION INSTRUCTIONS

**RECOMMENDED:** Suspension should be in good working condition.

Warepads may be installed on the OEM Hanger while on the trailer frame or off.

**TIPS:** DO NOT USE PRE-DRILLED OEM HOLES from the manufacturer. See Do's and Don'ts booklet at [www.warepad.com](http://www.warepad.com) for additional tips.

**CAUTION:** TOP OF WAREPAD MUST BE INSTALLED ON THE AXLE SIDE OF THE HANGER. SEE BELOW FOR DETAILS. INCORRECT INSTALLATION MAY RESULT IN WAREPAD BEING PUSHED OUT BY SPRING.

## PREPARATION OF HANGER WITH STEEL PAD:

- A:** When possible, remove existing wear pads, protection products, old existing welds and fasteners  
**B:** If installing Warepads over an existing wear pad, chamfer (sloping edge) and smooth down the edges of steel pad so that there are "NO SHARP EDGES". If Warepad is installed over a sharp object, it may cut the polypad and cause it to be damaged or fall out.  
**C:** If Steel Pads, the thickness of each steel pad in all the hangers and equalizers must be the same thickness to maintain a level suspension. An unlevel suspension may cause excessive wear to the Warepads.

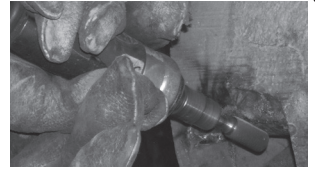

**BEFORE STARTING WAREPAD INSTALLATION:** A: Check Hanger for ADDED FLANGE OR GUSSET that will prevent Warepad from sitting tight to seat of Hanger. If the Warepad cannot sit tight due to a flange or gusset, go to Step B. If no flange or gusset go to Step 1.

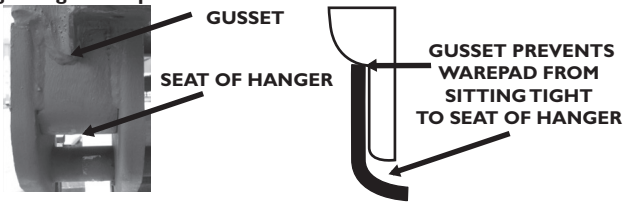

**B:** You can Trim or Notch Out the "TOP OF THE HANGER WAREPAD" that will allow the Warepad to sit tight to the seat of the hanger IF BOTH OF THE FOLLOWING ARE TRUE:

1. The lowered Hanger Bolt Location will not be in the path of the spring movement.
2. Bolt and Washers will be on a FLAT TIGHTENING SURFACE.

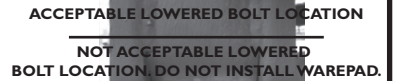

**Attachment Hardware per Warepad:**  
 2 - 5/16" Bolts  
 4 - 5/16" Flat Washers  
 2 - 5/16" Self Locking Nuts

**Equipment/Tools Needed for Installation:**  
 5/16" Drill Bit  
 Drill Motor  
 Marking Pen  
 1/2" Open End Box Wrench  
 3/8" Drive Ratchet Wrench  
 3/8" Drive 1/2" Socket  
 Red Loctite Series 271

**Step 1:** Locate top of Warepad. Mark the location as "Top."



**Step 2A:** Use the Heavy Duty 5/16" Flat Washers as a guide to mark drill hole location on Warepad. If Warepad has been adjusted due to added flange or gusset, adjust Flat Washers location as needed.

**Step 2B:** Drill 5/16" holes thru Warepad at drill hole locations.

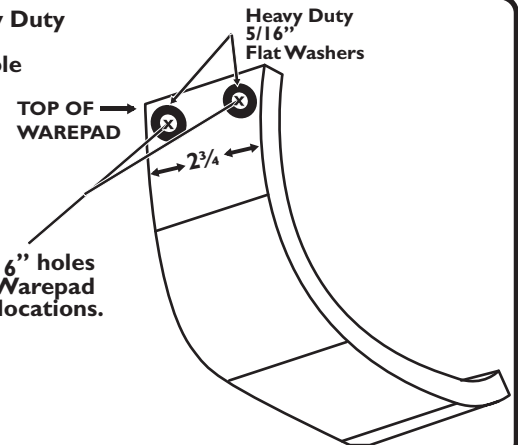

**Step 3:** Use the drilled Warepad from Step 2 as a guide to mark OEM hanger.

Top of Warepad on axle side of hanger.

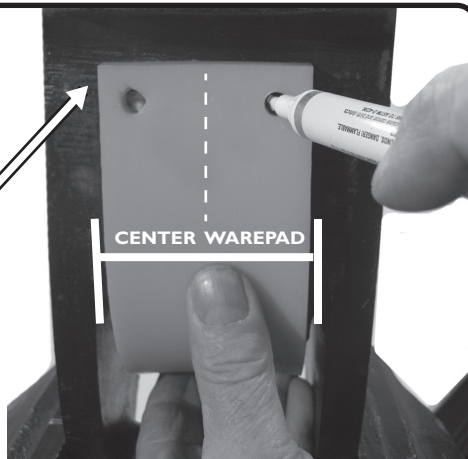

**Step 4:** Drill 5/16" holes into OEM hanger.

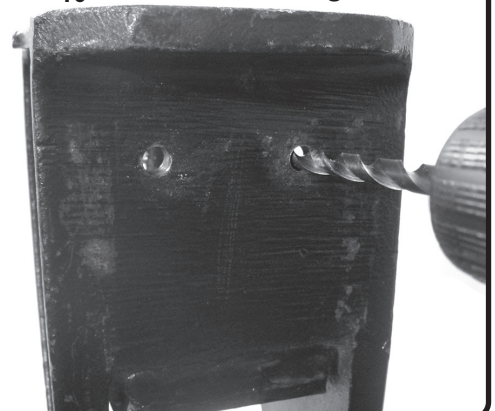

# WAREPAD PART NUMBER: EWP HH1 - INSTALLATION INSTRUCTIONS

## Step 5A-C: FASTENER INSTALLATION/TIGHTENING.

**5A.** Use Red Loctite Series 271 on the thread of the bolt when installing fasteners.

**5B:** Install fasteners according to diagram in Step 6.

**5C: Bolt Tightness.** There is no torque for bolt tightness. Snug the bolt. Bolt tension should be done manually with a 3/8" Drive Ratchet Wrench, 1/2" Open End Box Wrench and 3/8" Drive 1/2" Socket. Maximum tightening is reached when the Flat Washer presses into the polypad surface to cause a minor indentation. The washer may bend slightly. **CAUTION! DO NOT OVER-TIGHTEN TO CAUSE the washer to invert or buckle.**



**Step 6: Place Warepad onto underside of OEM Hanger.** Line up holes. Top of Warepad must be on the axle side of Suspension. Install fasteners **MANUALLY** (Steps 5A-C) with Red Loctite Series 271 on the thread of the bolt. **VERY IMPORTANT!** See Steps 5A-C for Fastener Installation/Tightening.

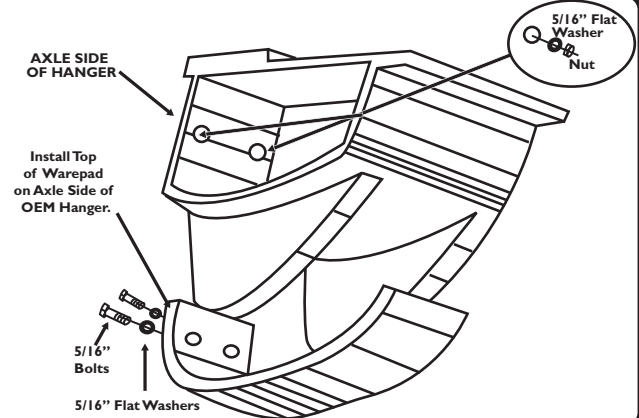

**Pictured:**  
A Front Hanger  
installed with  
fasteners

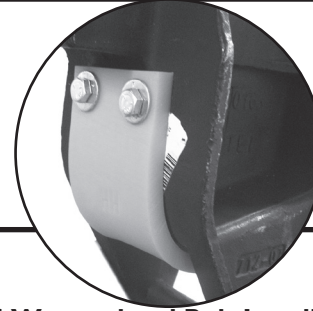

**Pictured:**  
A Rear Hanger  
installed with  
fasteners

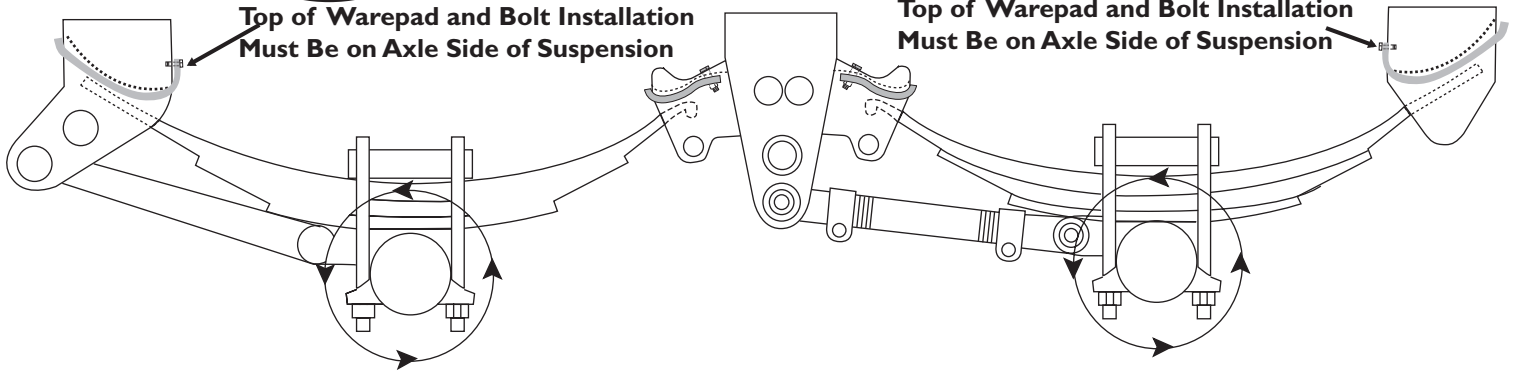

## **EWP Maintenance Recommendation immediately after installation:**

**Once the weight of the suspension has been dropped back down upon the axles, it is recommended to re-check the fastener tightness. The weight of the suspension may cause the Warepad to compress.**

If the Warepad is loose, re-tighten the fastener **MANUALLY** with a 3/8" Drive Ratchet Wrench, 1/2" Open End Box Wrench and 3/8" Drive 1/2" Socket so that the Warepad is being held tightly to the hanger or equalizer by the fastener system. There is no torque for tightness. Maximum tightening is reached when the washer that is directly on the Warepad presses into the polypad surface to cause a minor indentation. The washer may bend slightly. **DO NOT OVER-TIGHTEN** to cause the washer to invert or buckle.

**It is recommended to inspect the Warepads during routine maintenance schedules and during PM's.**

**For complete Maintenance and Inspection Procedures please check Install Manual or visit: [www.warepad.com](http://www.warepad.com).**